

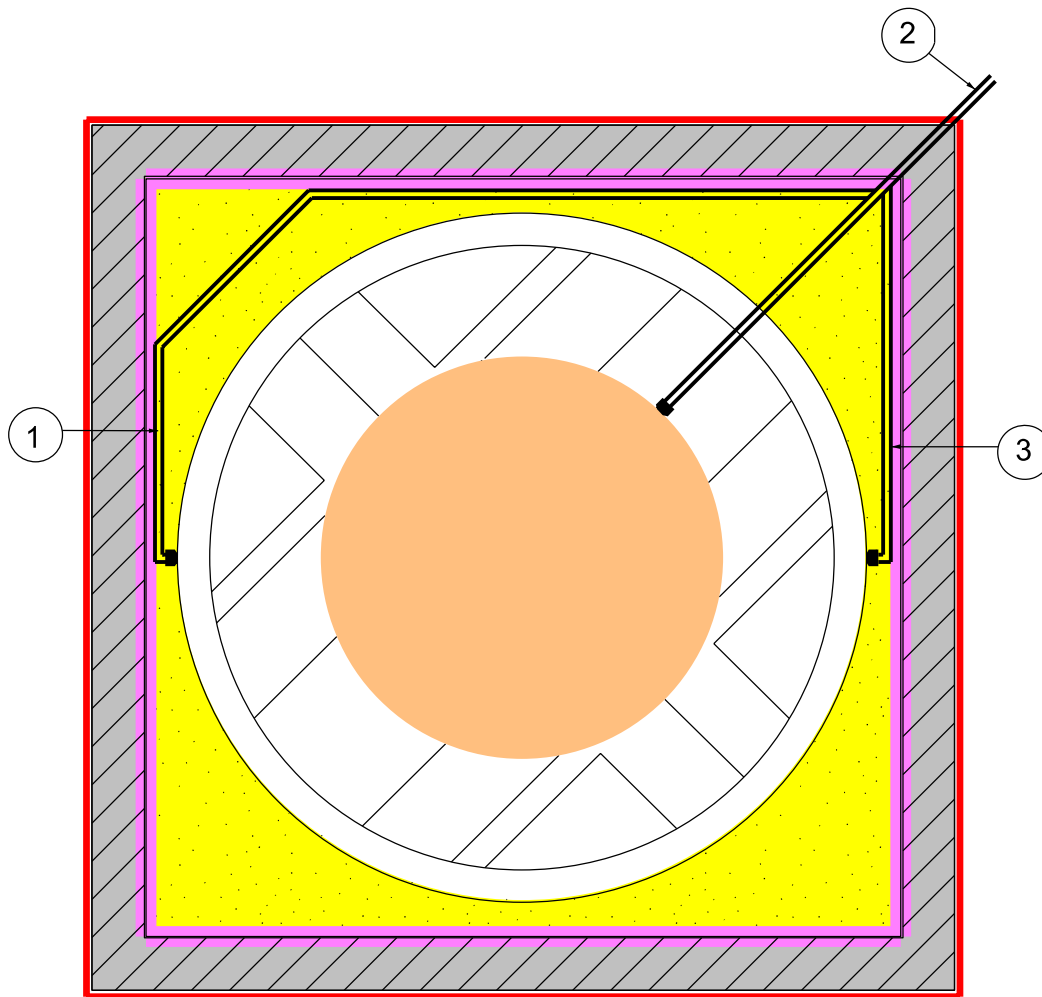

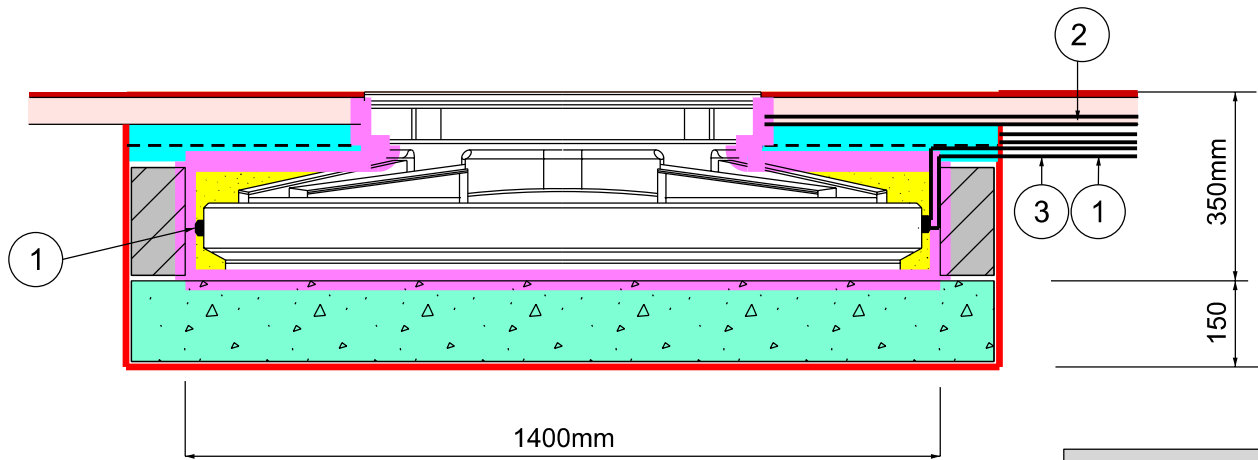









Winecellar Single Pod (27 Bottle) Installation Guidelines





Key

-  Floor Finish
-  Floor Screed
-  Concrete
-  Mesh Reinforcement
-  Butyl Bag
-  Dry Mix of Sand & Cement
-  Blockwork Retaining Wall
-  Concrete Base
-  D.P.C.

Polypipe Use

-  1 Airflow outlet to outside wall (air brick)
-  2 Electricity 3m pre-fitted cable to electric point
-  3 Airflow inlet to outside wall (air brick)

Misc.

-  Builders Protective Cover
-  15mm Push-fit Polypipe
-  15mm Polypipe Push Fit Connector